

# Hemostasis

## CLIPPING DEVICES

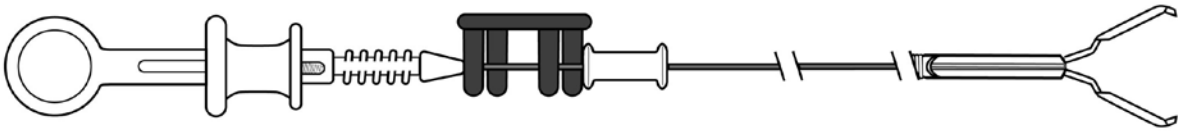

### Resolution™ Clip

Order Number	Description	Working Length (cm)	Minimum Working Channel (mm)	Clip Opening (mm)	Units
M00522600	Resolution Clip	155	2.8	11	box 1
M00522601	Resolution Clip	155	2.8	11	box 10
M00522602	Resolution Clip	155	2.8	11	box 20
M00522610	Resolution Clip	235	2.8	11	box 1
M00522611	Resolution Clip	235	2.8	11	box 10
M00522612	Resolution Clip	235	2.8	11	box 20

## MULTIPLE BAND LIGATORS

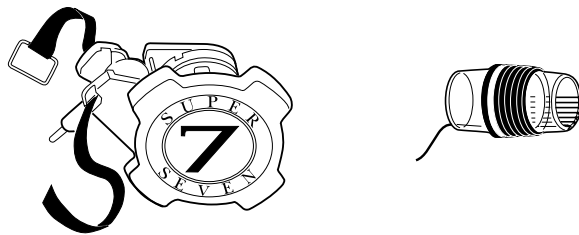

### Speedband Superview Super 7™ Multiple Band Ligators

Order Number	Description	Required Working Channel (mm)	Scope O.D. (mm)	Bands/Ligating Unit	Units
M00542250	Super 7 Band Ligator	2.8	8.6-11.5	7	box 1
M00542251	Super 7 Band Ligator	2.8	8.6-11.5	7	box 2
M00542253	Super 7 Band Ligator	2.8	8.6-11.5	7	box 4

# Hemostasis

## BIPOLAR ELECTROHEMOSTASIS CATHETERS

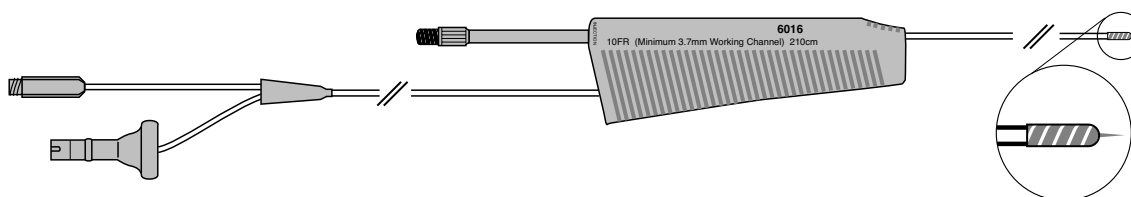

### Injection Gold Probe™ Electrohemostasis/Injection Catheters



Order Number	Description	O.D. (F) / (mm)	Needle			Working Length (cm)	Type Generator/ Connector	Units
			Gauge	O.D. (mm)	I.D. (mm)			
M00560150	Injection Gold Probe Catheter	7 / 2.33	25	0.51	0.24	210	Standard Plug*	box 1
M00560160	Injection Gold Probe Catheter	10 / 3.33	25	0.51	0.24	210	Standard Plug*	box 1

\* Compatible with Endostat™ Bipolar-Monopolar Electrosurgical Generators  
For Banana Plug Connector, use Electrosurgical Bipolar Cable Adapter, M00561360.

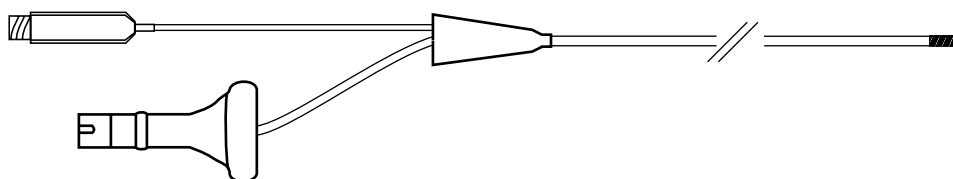

### Gold Probe™ Electrohemostasis Catheters



Order Number	Description	O.D. (F) / (mm)	Working Length (cm)	Type Generator/ Connector	Units
M00560070	Gold Probe Catheter	7 / 2.33	300	Standard Plug*	box 1
M00560100	Gold Probe Catheter	10 / 3.33	300	Standard Plug*	box 1
M00560220	Gold Probe Catheter	7 / 2.33	350	Standard Plug*	box 1
M00560071	Gold Probe Catheter	7 / 2.33	300	Standard Plug*	box 5
M00560101	Gold Probe Catheter	10 / 3.33	300	Standard Plug*	box 5

\* Compatible with Endostat™ Bipolar-Monopolar Electrosurgical Generators  
For Banana Plug Connector, use Electrosurgical Bipolar Cable Adapter, M00561360.

# Hemostasis

## NEEDLES

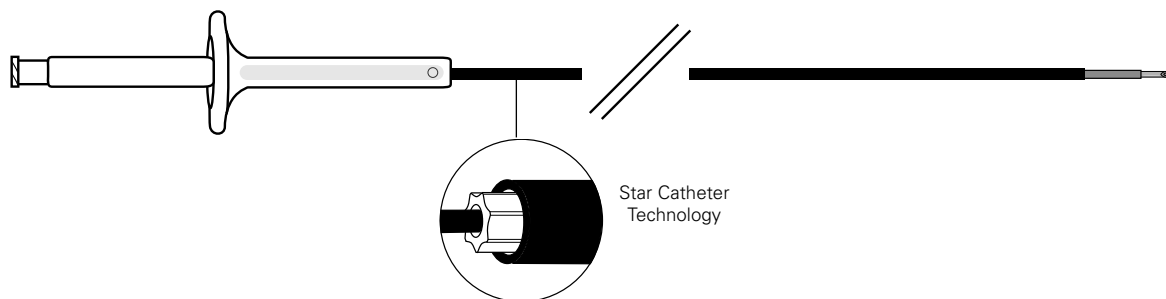

### Interject™ Sclerotherapy Needles\*



Order Number	Description	Sheath Design	Gauge	Needle		Sheath O.D. (mm)	Maximum Needle Extension Length (mm)	Working Length (cm)	Units
				O.D. (mm)	I.D. (mm)				
M00518151	Interject Sclerotherapy Needle	Contrast	23	0.64	0.32	1.8	4	200	box 5
M00518161	Interject Sclerotherapy Needle	Contrast	25	0.51	0.24	1.8	4	200	box 5
M00518251	Interject Sclerotherapy Needle	Contrast	23	0.64	0.32	1.8	6	200	box 5
M00518261	Interject Sclerotherapy Needle	Contrast	25	0.51	0.24	1.8	6	200	box 5
M00518351	Interject Sclerotherapy Needle	Contrast	23	0.64	0.32	2.3	4	240	box 5
M00518361	Interject Sclerotherapy Needle	Contrast	25	0.51	0.24	2.3	4	240	box 5

\* With Star Catheter Technology.

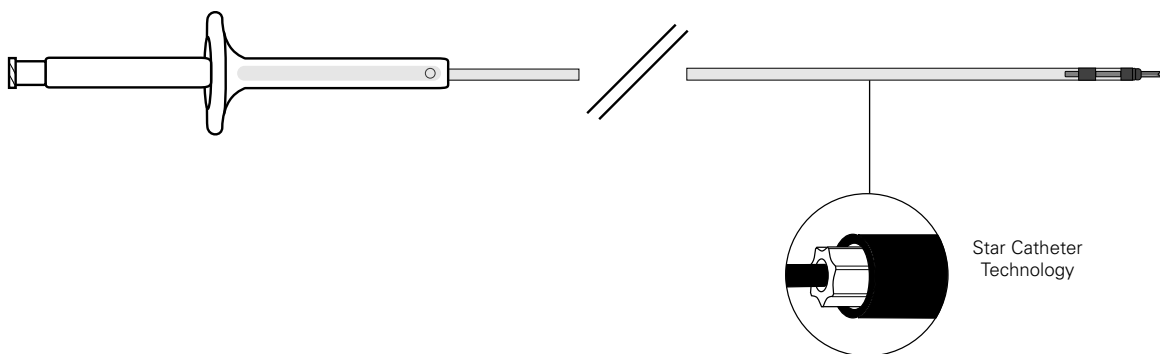

### Interject™ Clear Sclerotherapy Needles\*



Order Number	Description	Sheath Design	Gauge	Needle		Sheath O.D. (mm)	Maximum Needle Extension Length (mm)	Working Length (cm)	Units
				O.D. (mm)	I.D. (mm)				
M00518111	Interject Sclerotherapy Needle	Clear	25	0.51	0.24	1.8	4	200	box 5
M00518301	Interject Sclerotherapy Needle	Clear	23	0.64	0.32	2.3	4	240	box 5
M00518311	Interject Sclerotherapy Needle	Clear	25	0.51	0.24	2.3	4	240	box 5

\* With Star Catheter Technology.

# Hemostasis

## NEEDLES (CONTINUED)

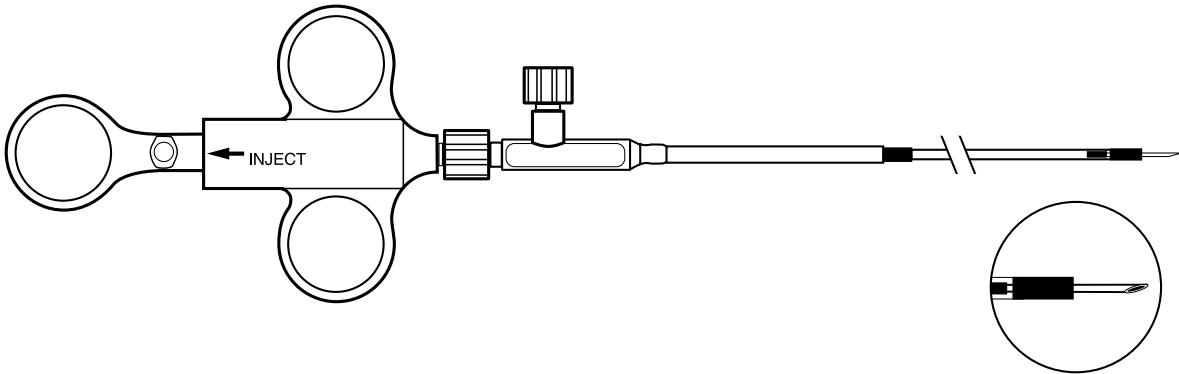

### Optiflo™ Hemostasis Catheters



Order Number	Description	Needle Gauge	Needle		Sheath O.D. (mm)	Working Length (cm)	Working Channel (mm)	Units
			O.D. (mm)	I.D. (mm)				
M00511731	Optiflo Hemostasis Catheter	23	0.64	0.32	2.3	200	2.8	box 5
M00511751	Optiflo Hemostasis Catheter	25	0.51	0.24	2.3	200	2.8	box 5

## ELECTROSURGICAL BIPOLAR CABLE ADAPTER

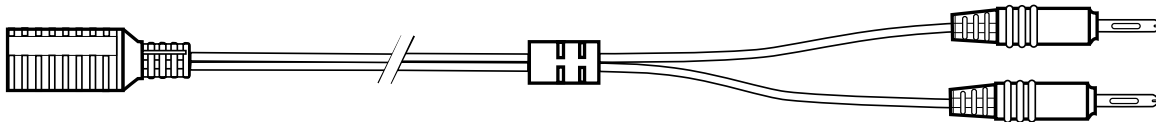

### Electrosurgical Bipolar Cable Adapter

Order Number	Description	Type Generator/ Connector	Units
M00561360	Bipolar Cable Adapter	Banana Plug*	box 1

\* Compatible with most Brand Generators w/bipolar capabilities.